

# Velkommen som seiler!

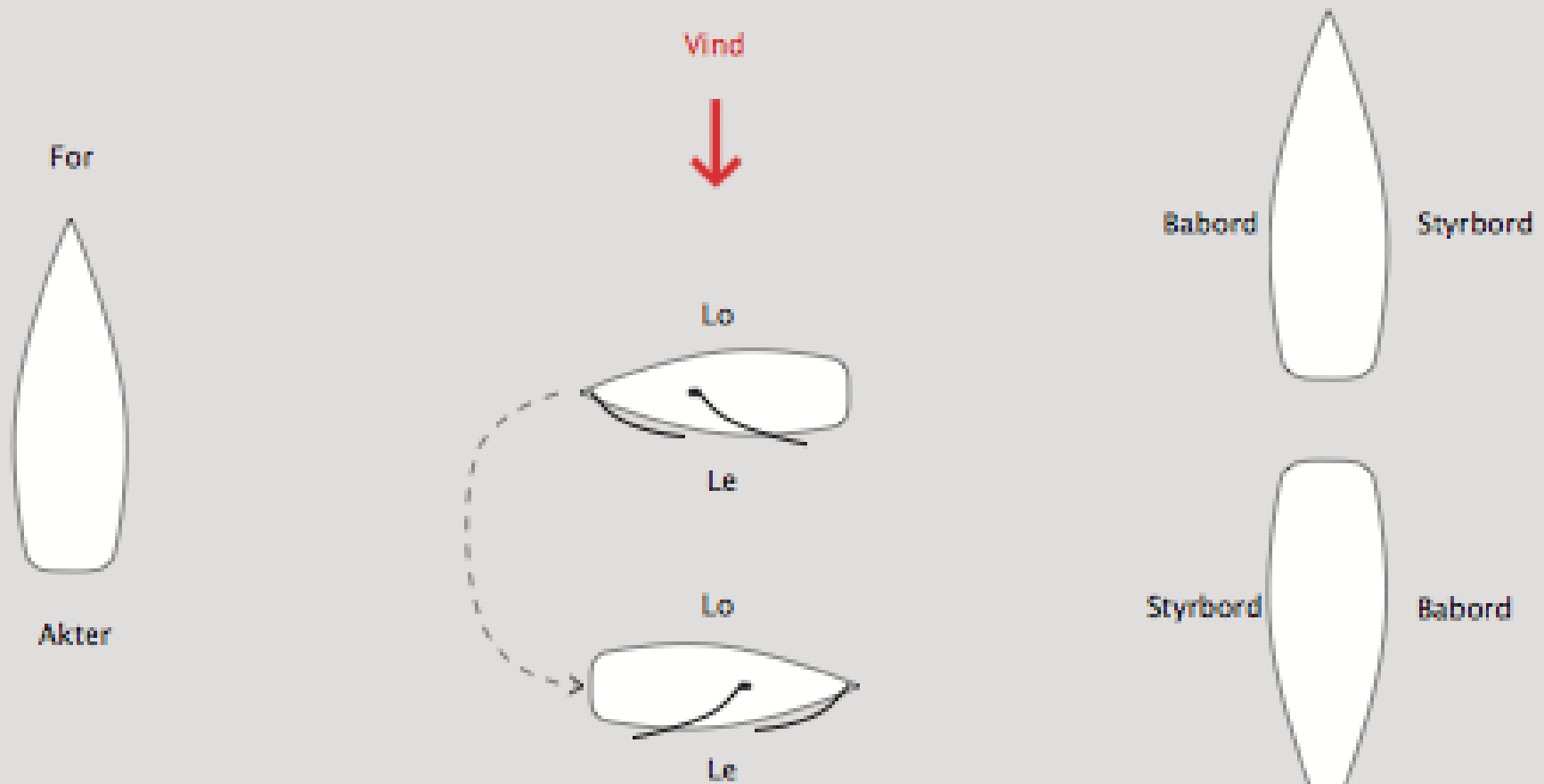

# Retninger til sjøs



Vind



Vindøyet/Slag

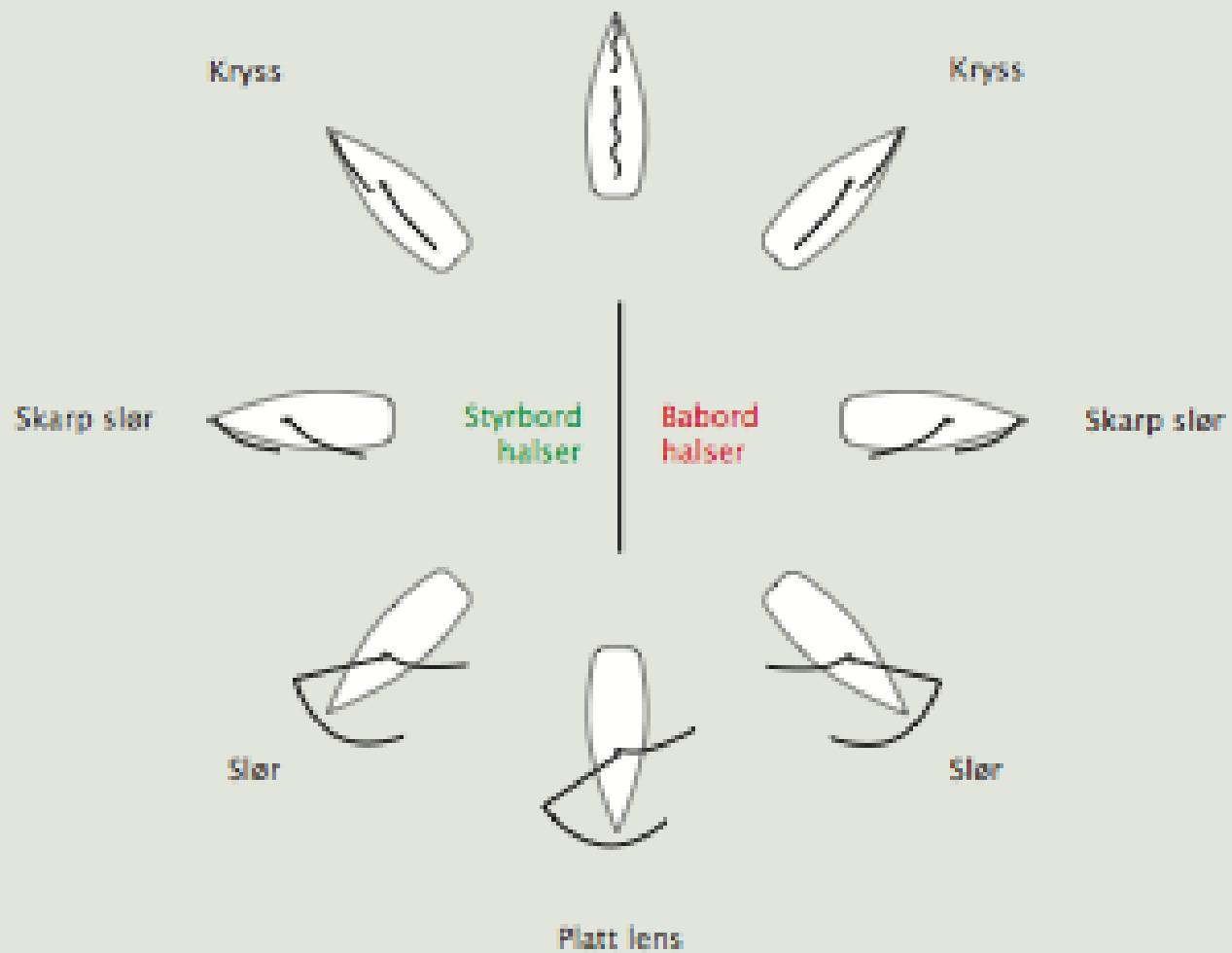

# Storseil



# Fokk/Genoa



# Spinnaker



# Gennaker





⌘ Fall



⌘ Skjøter



⌘ Trimliner





Hva gjør man?



Vind



Seile mot vinden?

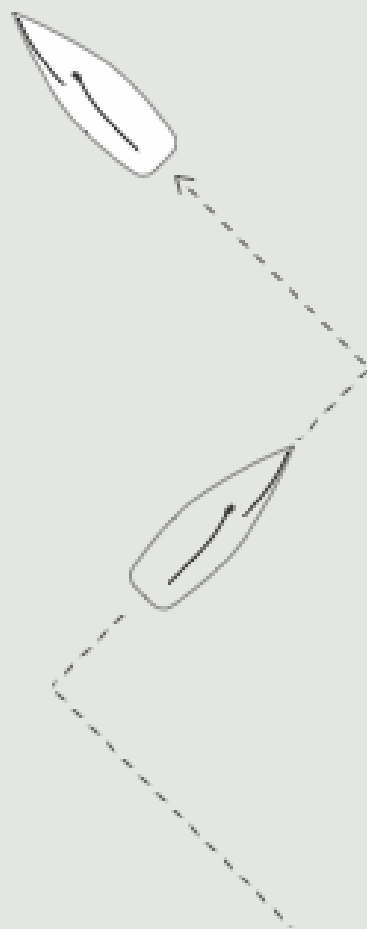

# Kryssvinkel

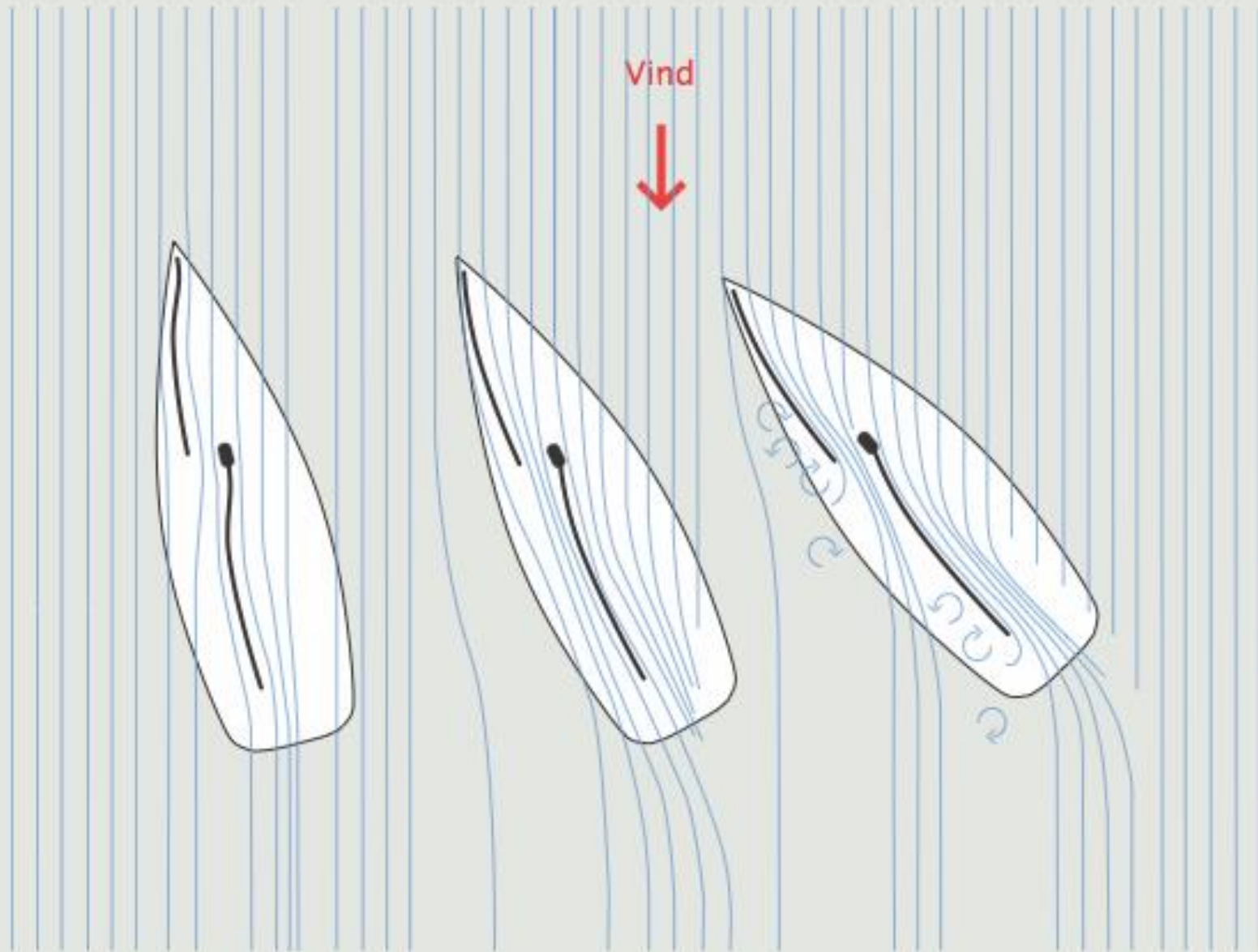

# Styre eller skjøte?

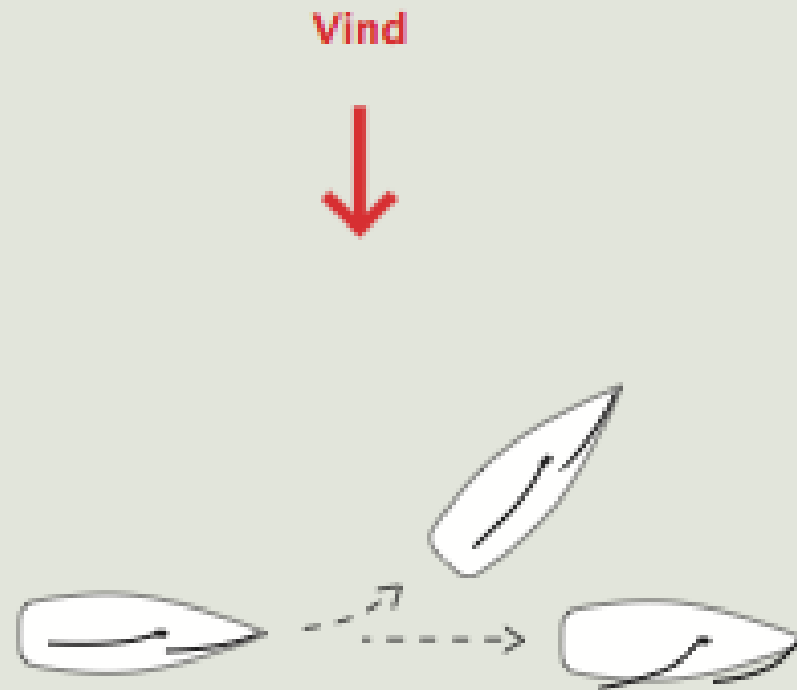

Hva er Lus?



# Styr etter lusene:

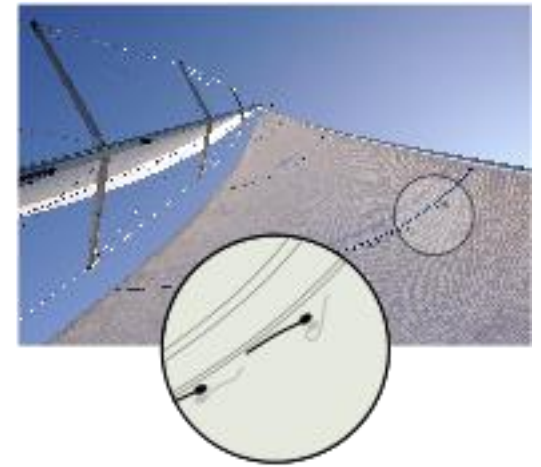
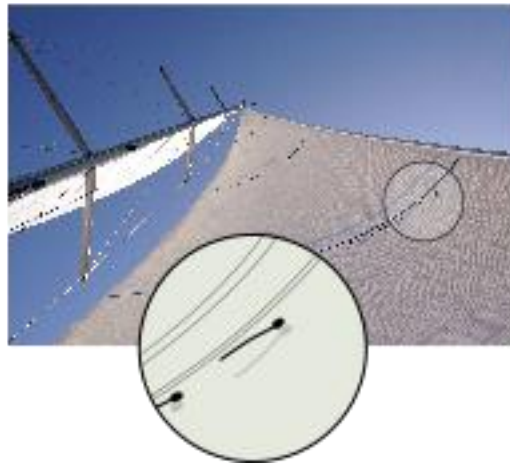
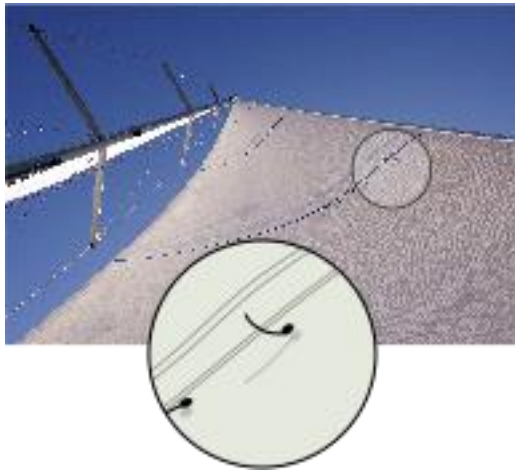

# Laminær luftstrøm

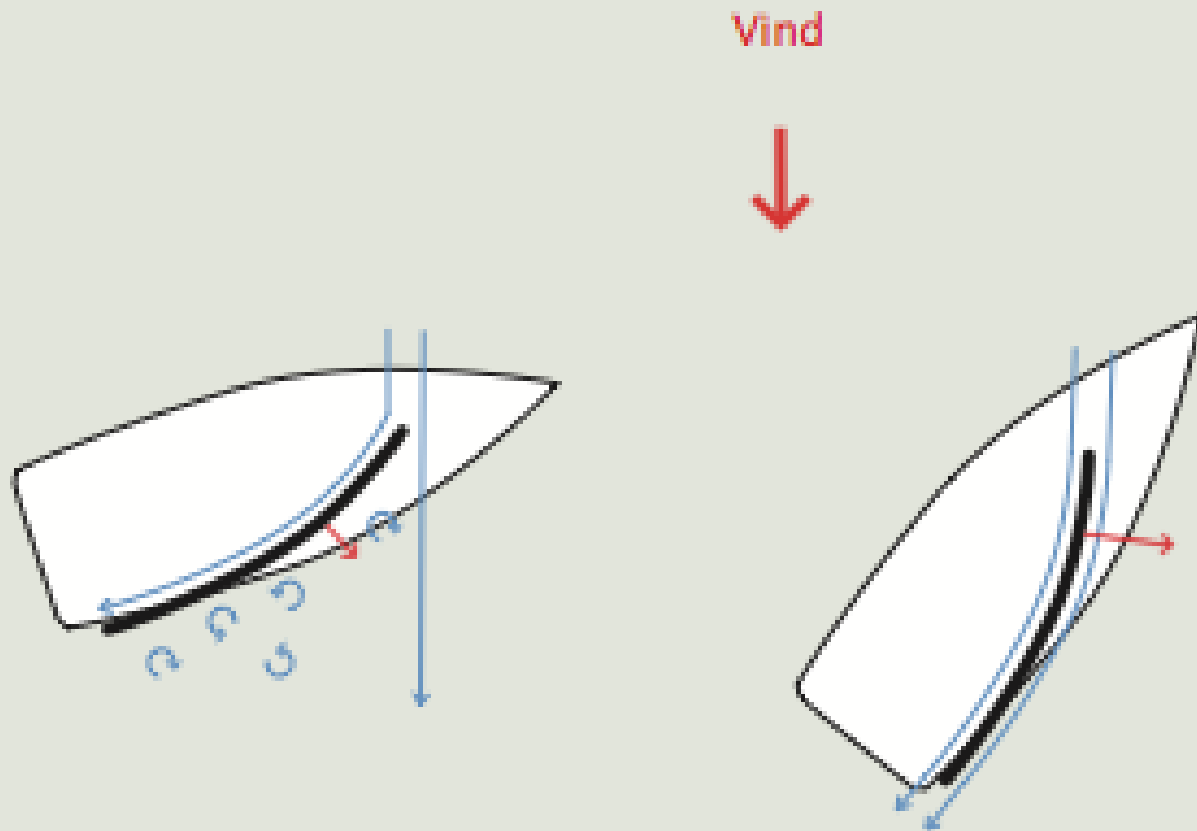

# Fart vs. høyde

Vind

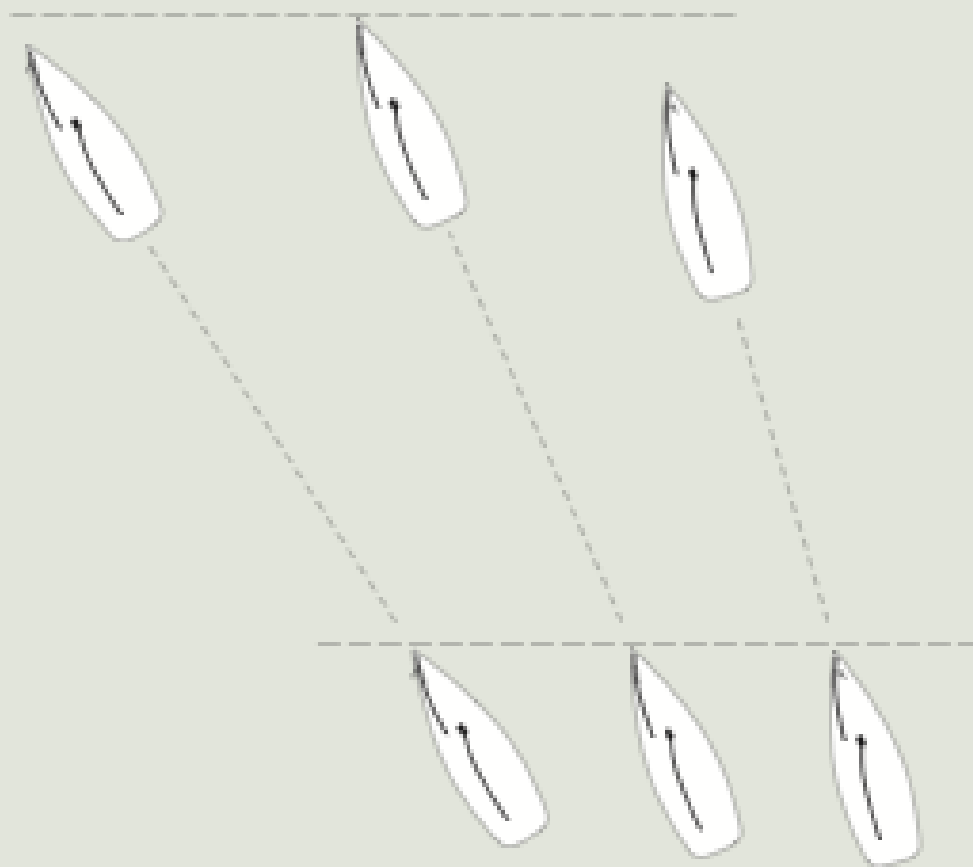



# Hva heter det?



Vind



Babord halser

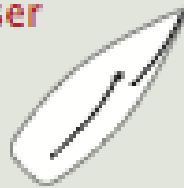

Styrbord halser

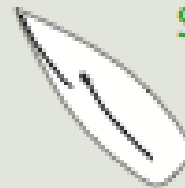

Vind



Loffe

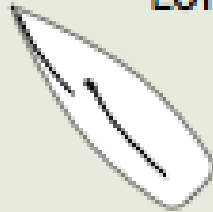

Falle av



# Slag

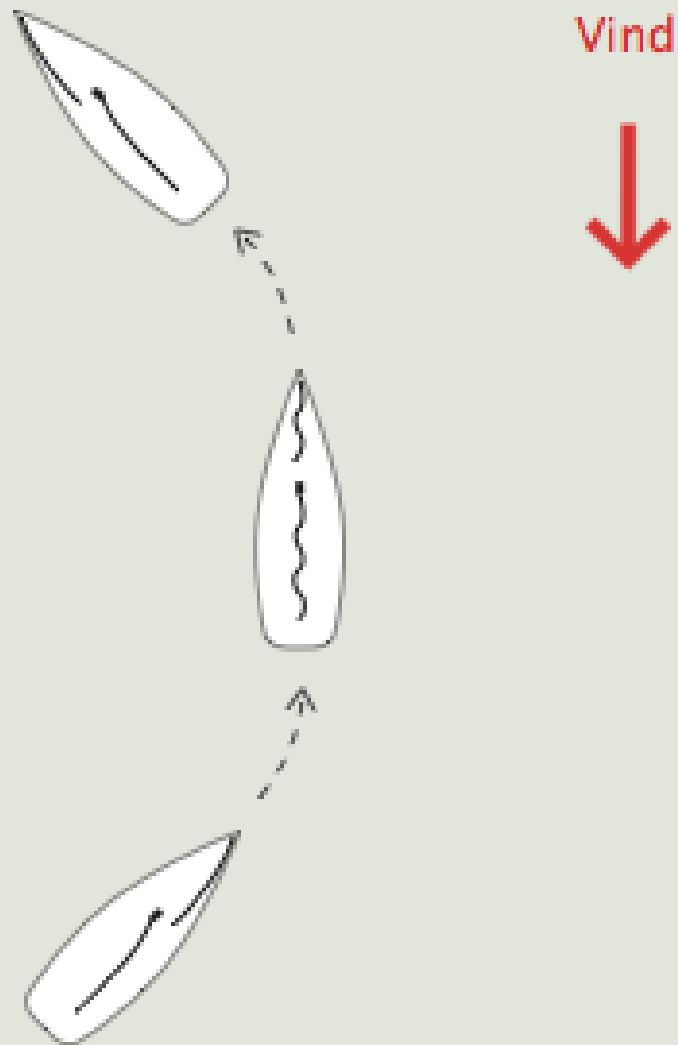

Vind



Slør

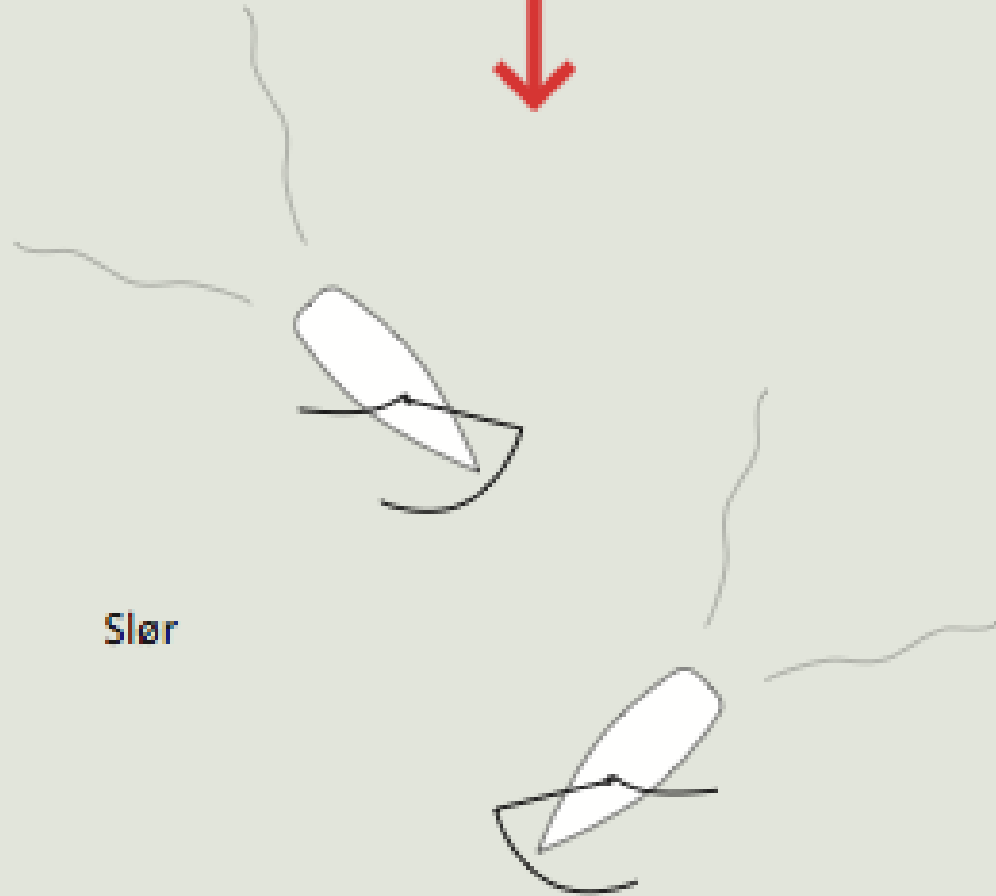

Vind

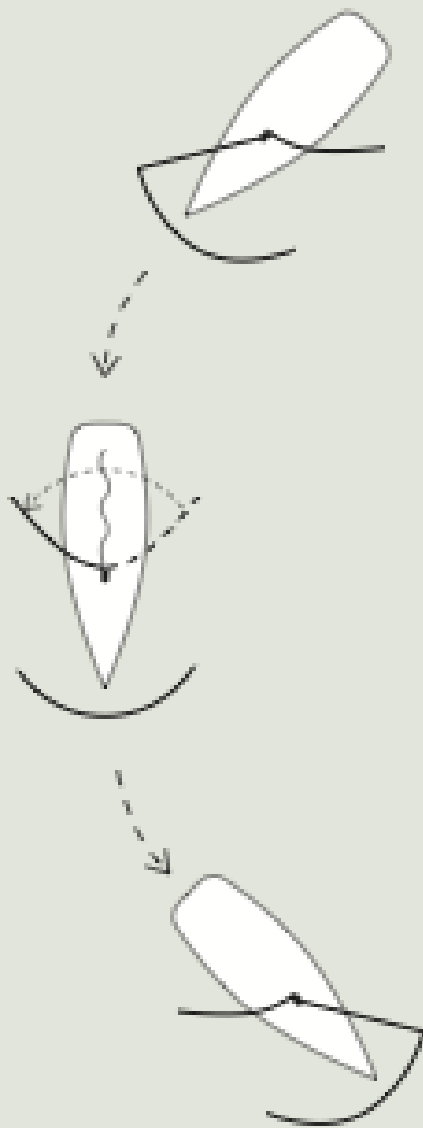

Jibb



Lens



# Havnemanøvrering og fortøyning





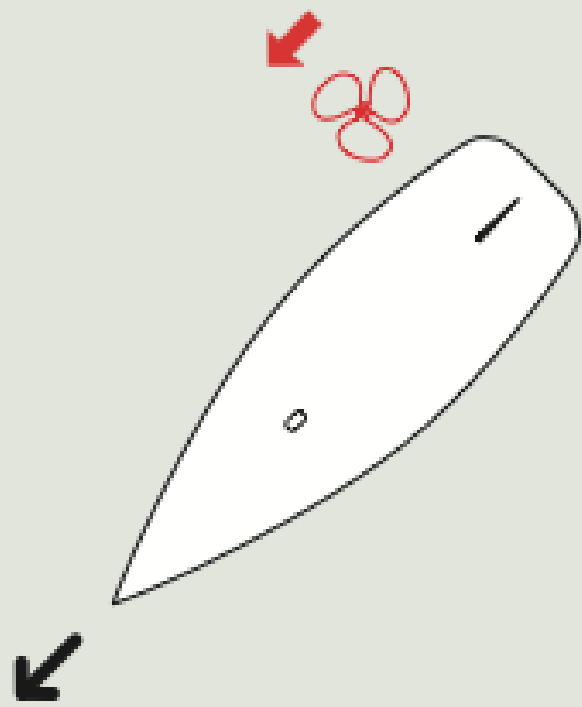
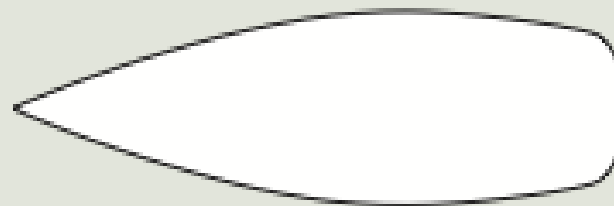
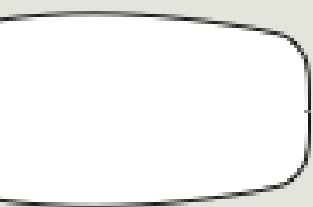

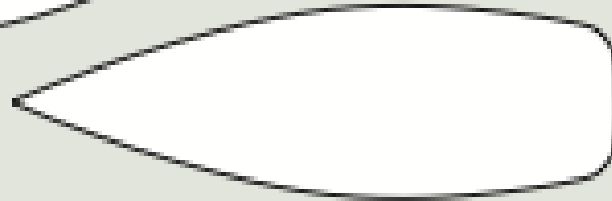
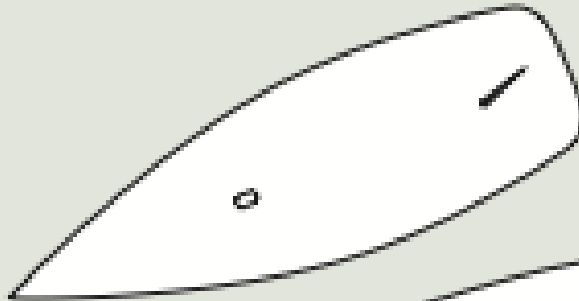
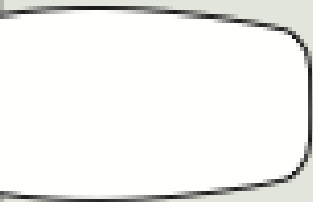

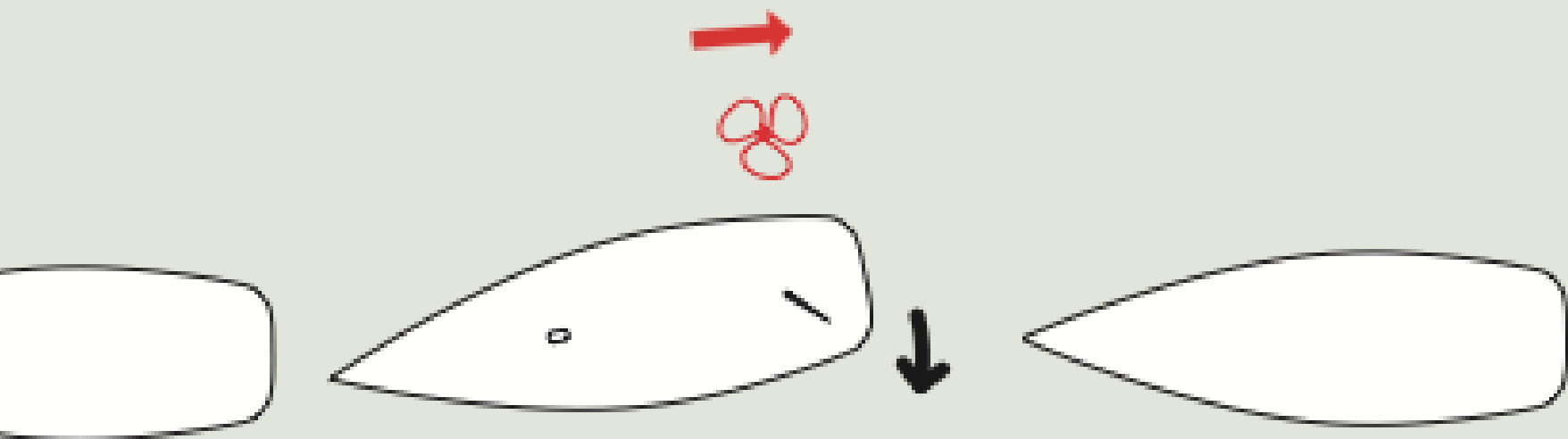

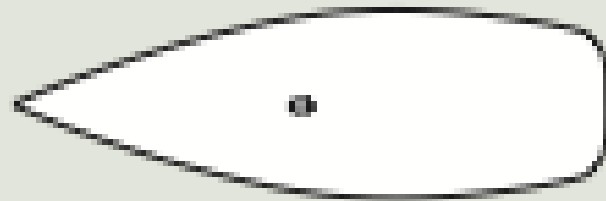
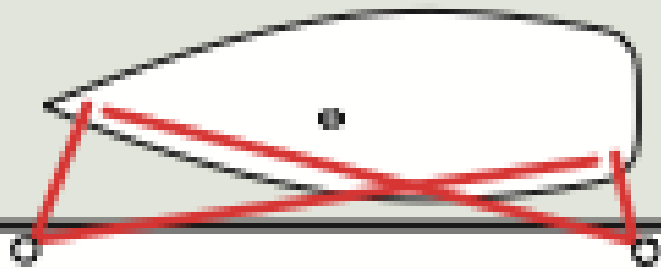

Reve storseil?



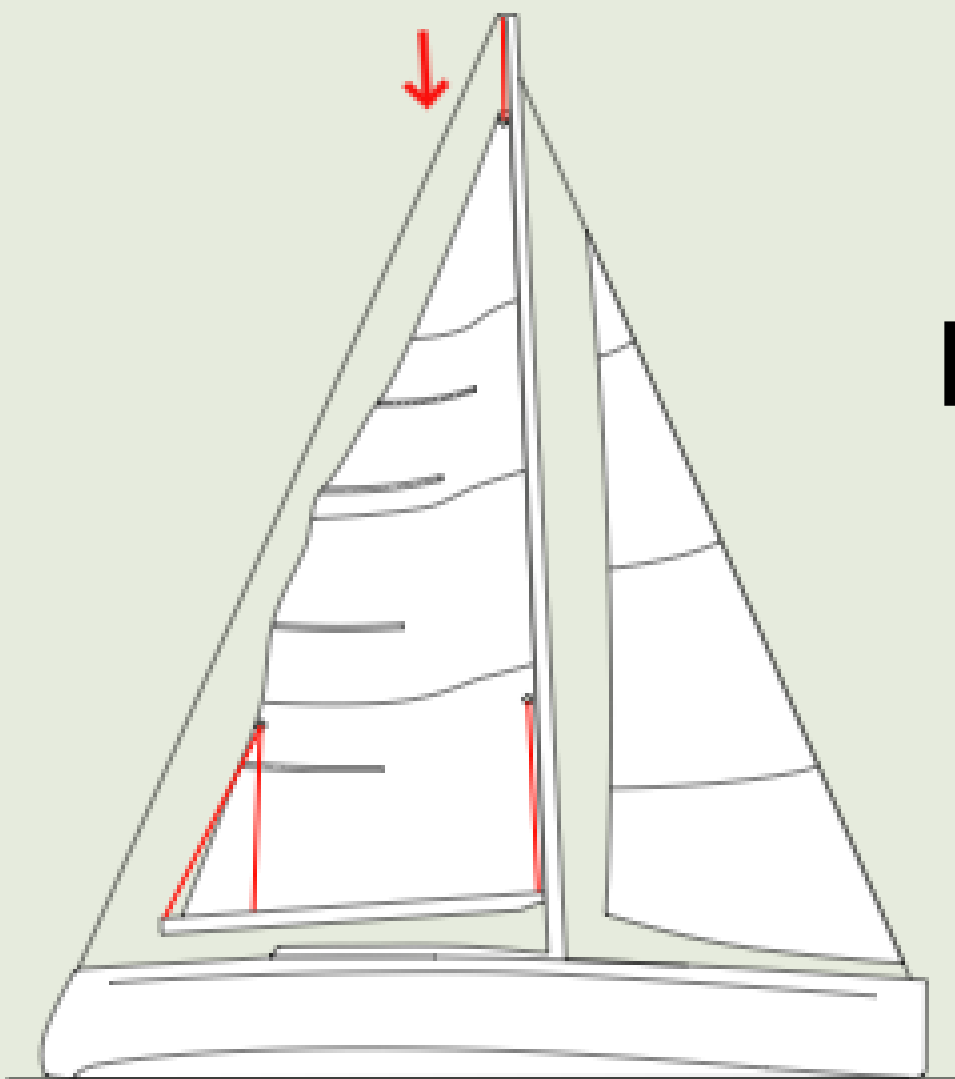

Løsne fallet



# Fest revemaljen

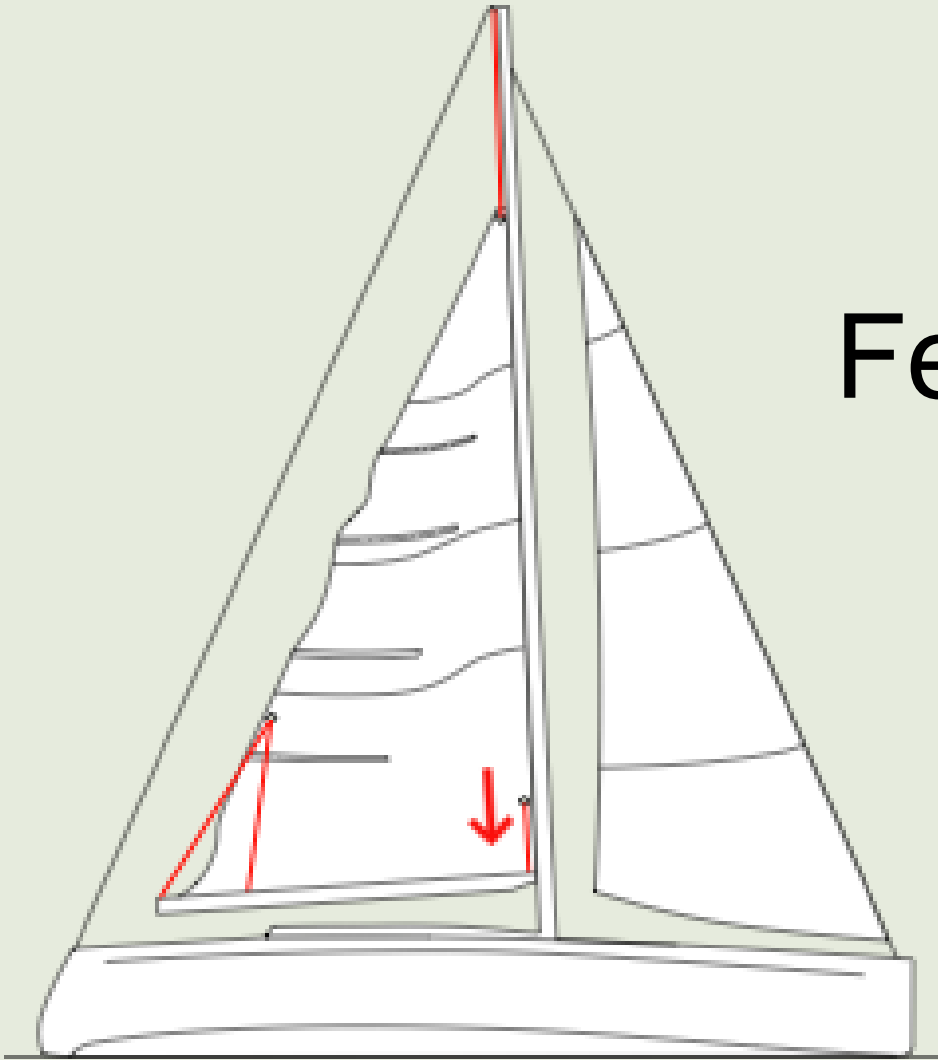

# Stram fallet

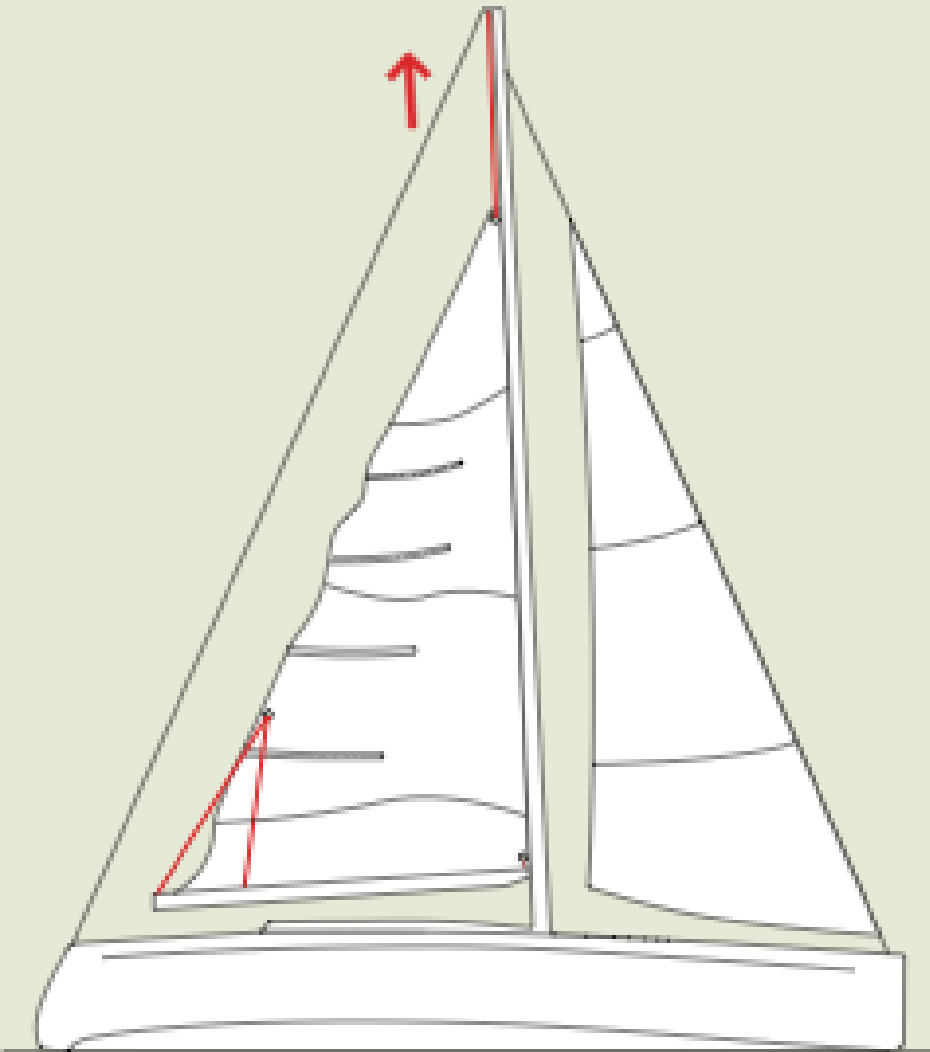



# Stram revelinen

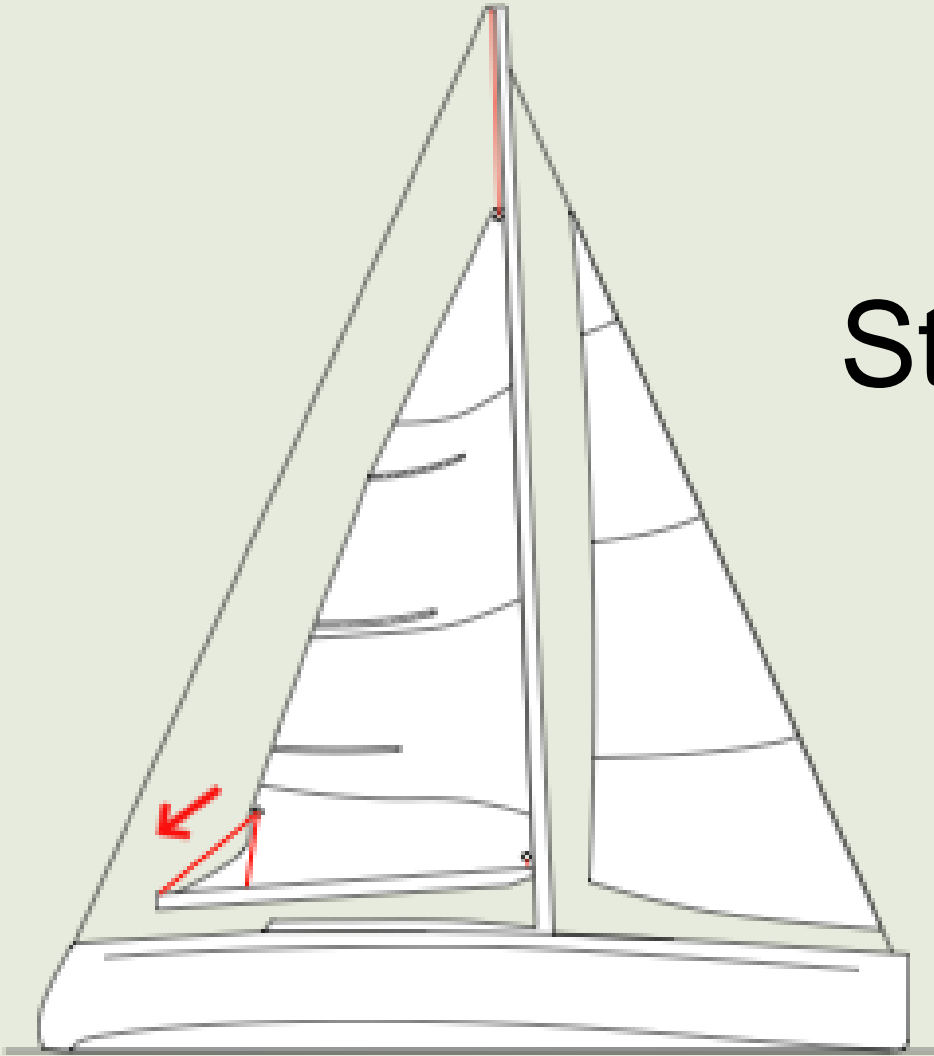

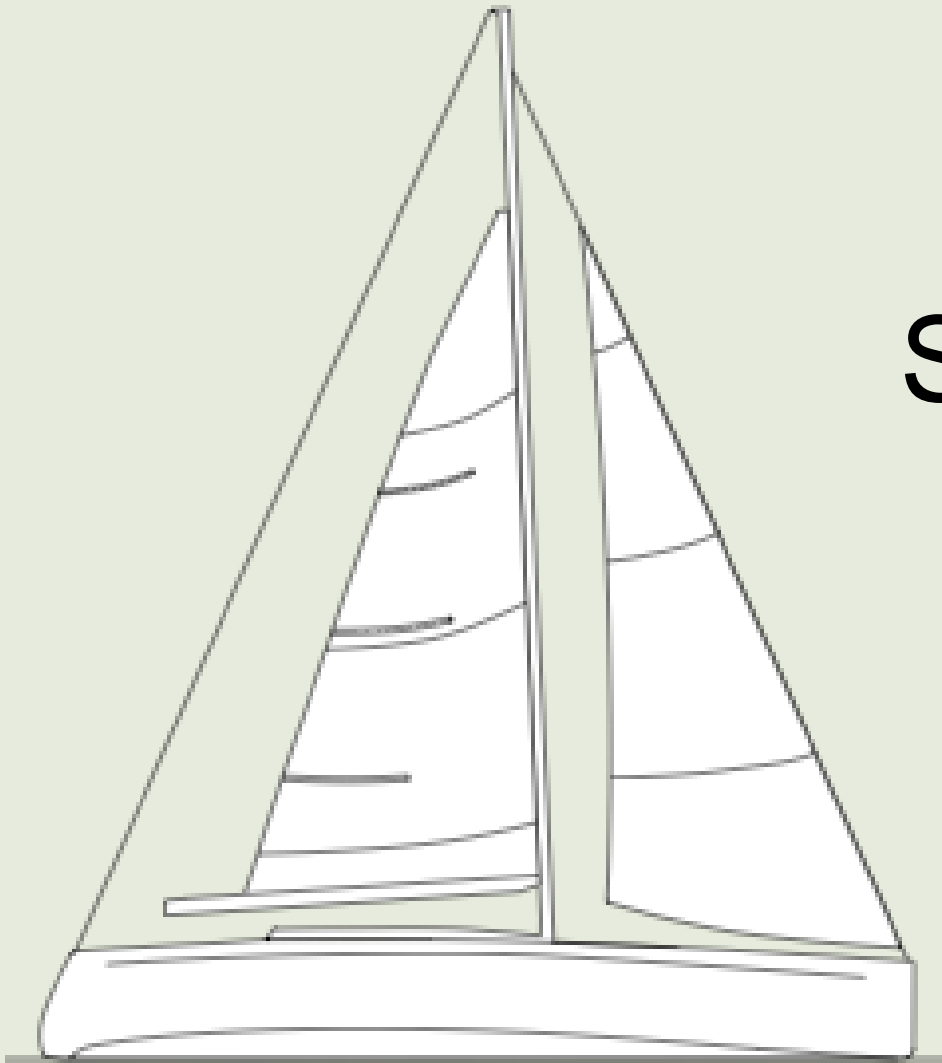

Seil videre :-)





- ⊗ Ikke fall i vannet
- ⊗ Ikke få bommen i hodet



# Quick stop!



# Regattaseiling



Entype



# Handicap



Vind



# Baner

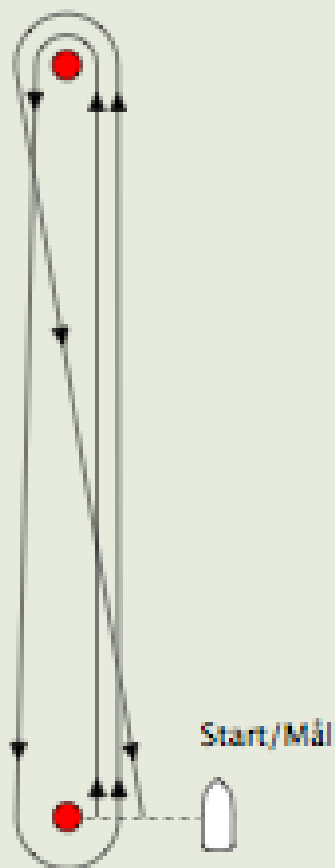

Pølsebane

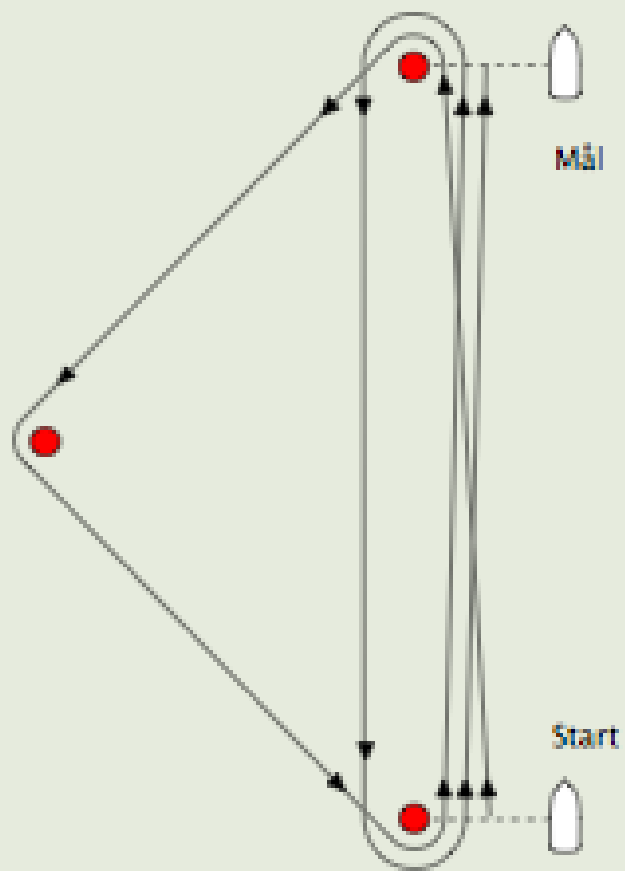

Trekantbane

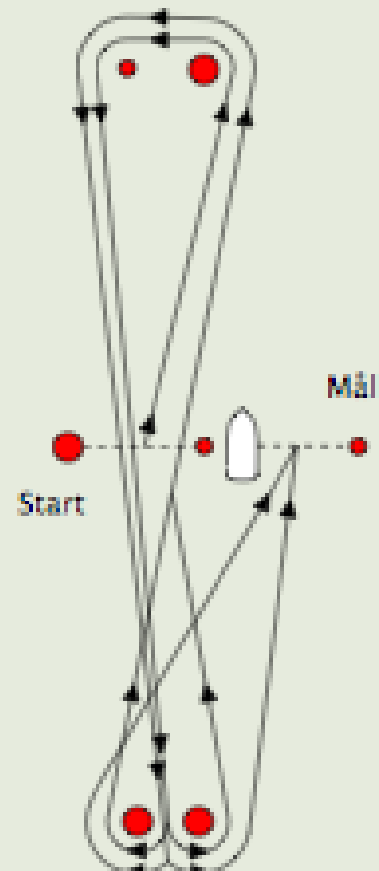

Pølsebane m/gate





# Faste merker



# Startprosedyre



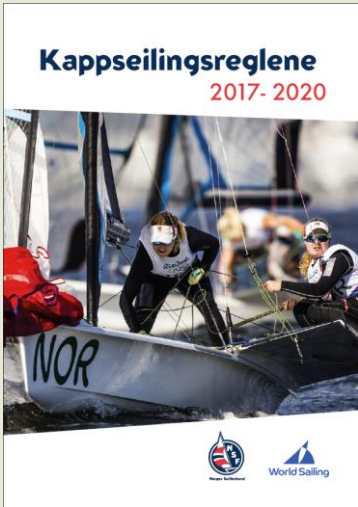

# Kappseilingsreglene

Vind

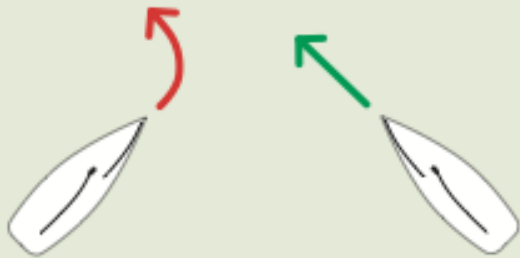

Babord halser

Styrbord halser

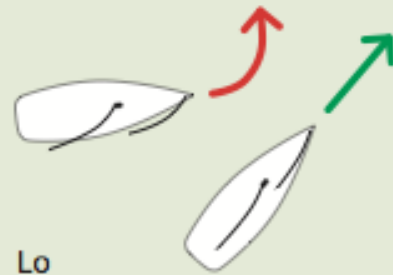

Lo

Le



# Spinnaker og gennaker



Sette gennaker



Vind



Sette spinnaker

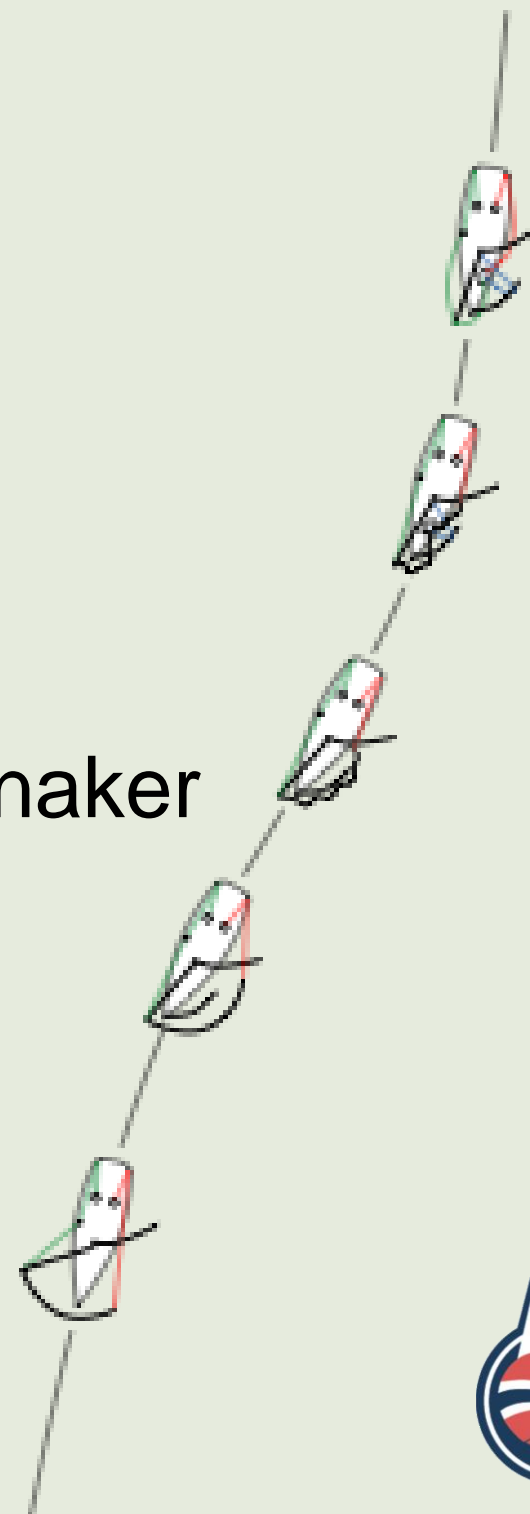

«prøv,  
spør og  
bli bedre!»

